

LED Recessed Square Downlight



TIS RSAL86J

Application

Recessed downlight is designed to use for office buildings, shopping centers, convenience stores, modern trade stores, discount stores, hotels, restaurants, residences, recreation centers, museums, etc.

Specification

Housing Description
 Die-cast aluminium
 Primary reflector : Vacuum aluminum plating PC/ High quality lens
 4 different secondary reflectors are available for various applications
 WR (front reflector white)
 BR (front reflector black)
 MB (front reflector mirror black)
 MI (front reflector mirror chrome)

Finishing
 Powder coated in white

Mounting
 Recessed

Power
 14/18W

Light Source
 LED COB

Colour Temperature
 3000K/4000K/5000K

CRI
 >90/ >90/ >80

Lamp Output
 14W : 1540/1660/1805 lm
 18W : 1980/2134/2320 lm

Luminaire Output
 14W : 1460/1562/1671 lm *
 18W : 1808/1934/2069 lm *

Beam Angle
 15/18/26/38/55 Degree

UGR
 <19

Control Gear
 Separate Driver

Power Supply
 220-240VAC, 50Hz

Power Factor
 >0.9

Insulation Class
 I

IP Rating
 20

Luminaire Lifetime
 40,000 hrs

Remarks
 * Value at 38 Degree

Ordering Data

Model	Watt
RSAL86J/MI/WH-14LED	14W
RSAL86J/MI/WH-18LED	18W

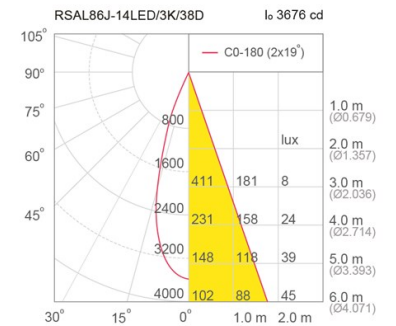
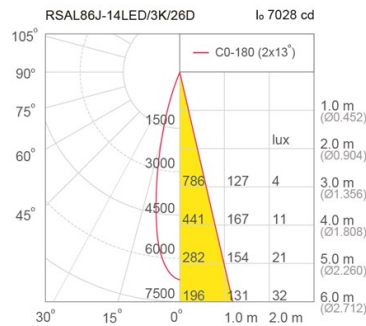
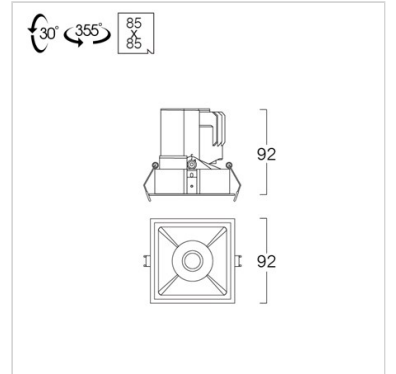
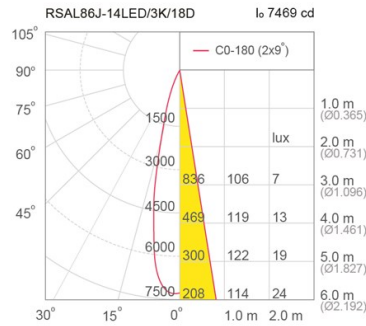
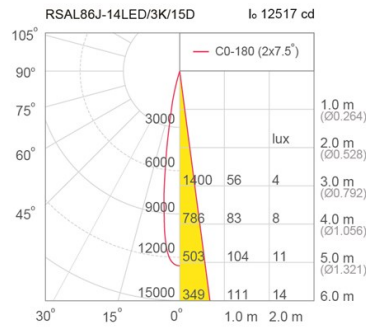

Related Products

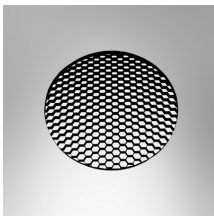

Honey comb

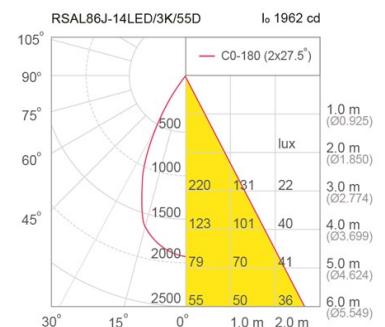

RSAL86J

14W

18W

15D

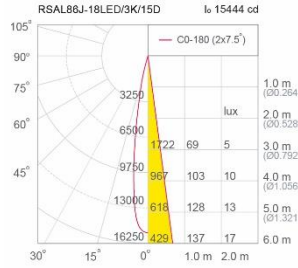
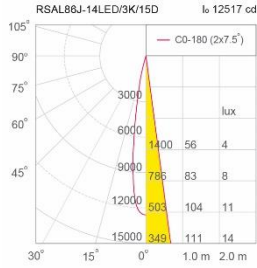

18D

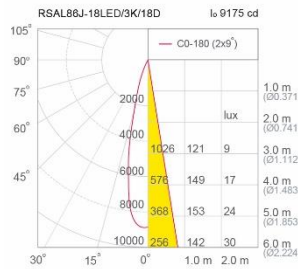
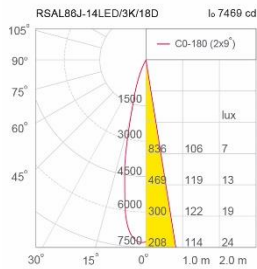

26D

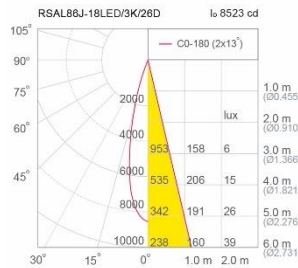
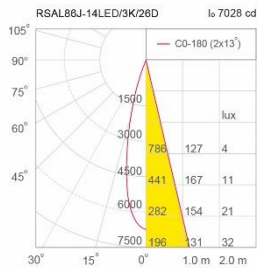

38D

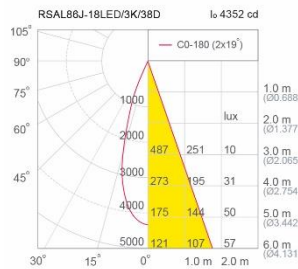
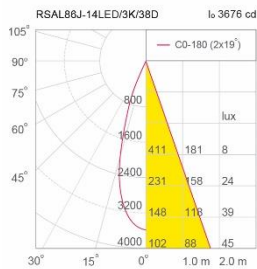

55D

